

Ceiling hook, lightweight (35 mm Ø)

With handle 35 mm Ø, hook part made from forged steel, galvanised hook and coupling pieces.

Type 1:

Ceiling hook, consisting of hook part and wooden handle 2.5 m.

Type 2:

Ceiling hook, two-piece, with two couplings, 2.5 m.

Type 3:

Ceiling hook, three-piece, with four couplings, 3.0 m.

Order no.	Model	Length m	Weight g
210410	1	2,5	2700
210420	2	2,5	3600
210430	3	3,0	4900
210422	Spare handle for 1-piece		1000
210424	Spare handles for 2-piece (2 pc.)		1000



made
in
Germany

DÖNGES
exclusive

C

V

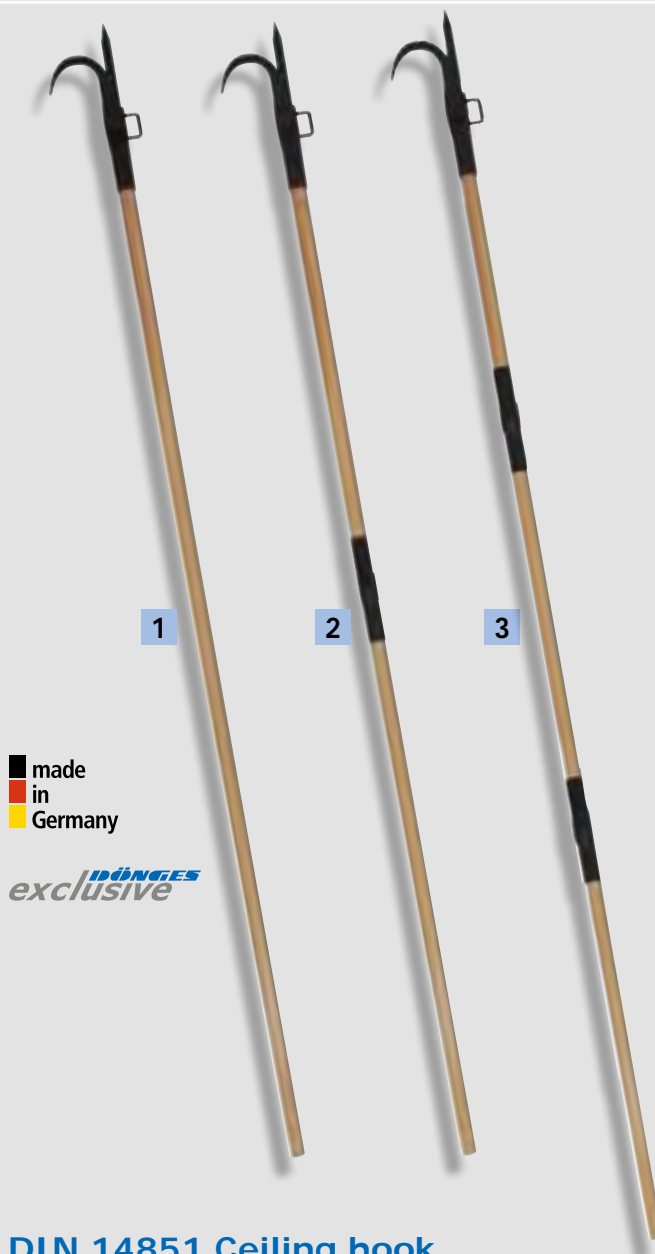

made
in
Germany

DÖNGES
exclusive

DIN 14851 Ceiling hook (50 mm Ø)

With handle 50 mm Ø, hook part made from forged steel. Galvanised hook and coupling parts.

Type C:

Ceiling hook, consisting of hook part (DIN 14851-1), wooden handle 2.5 m and coupling part H (DIN 14851-2).

Type V:

Extension (DIN 14851-3), consisting of wooden handle 2.5 m and coupling part V.

Type A:

5 m long (DIN 14851-5), consisting of types C and V.

Order no.	Model	Length m	Weight g
210450	A (=C+V)	5,0	8300
210460	C	2,5	4300
210470	V	2,5	4000
210462	Spare handle for C		3000
210472	Spare handle for V		3000

Nupla fibre glass handle

Nupla fibre glass handles are characterised by their outstanding robustness and sturdiness. The extraordinary strength of the handles is achieved using a special manufacturing method in which the glass fibres are aligned in one direction before they are given their shape by means of heat and high pressure. At 70%, the proportion of glass fibre is greater than the amount used by any other fibre glass handle manufacturer.

This special sturdiness and the fact that the fibre glass handle has extremely good insulating properties against electricity and heat and cold is an extremely positive safety factor for the user.

Nupla handles are easy to recognise by the black "vein" on the yellow handle. Only these handles have the major benefits that have been mentioned.

Features:

- Extremely strong
- Proportion of glass fibre in handle >70%
- Extremely good insulation against voltage
- Extremely good insulation against heat and cold
- Long service life, no material ageing



With stable honeycomb structure



Combination option



1



2



Ceiling hooks with Nupla fibre glass handle

The specially shaped ceiling hooks with NUPLA handle are similar to the German ceiling hooks, but have significant benefits during use. They are considerably lighter yet sturdy and resistant to moisture and wetness, and also to temperature fluctuations. The NUPLA handle also insulates extremely well. These properties have made it a standard for the fire brigades in the USA. The ceiling hooks are available with a straight handle or a D-grip.

Features:

- Feather light but yet extremely stable
- Sturdy, forged hook parts
- Choice of two handle shapes
- Good electrical insulation
- Extremely good price/performance ratio

	Order no.	Handle shape	Length cm	Weight g
1	210441	Straight	183	2900
2	210442	D-grip	183	3600
	210444	Straight	244	3300
	210446	D-handle	244	4000
	210447	Straight	305	3700
	210449	D-grip	305	4400

Ripping hook with Nupla fibre glass handle

The specially shaped ripping hooks with NUPLA handle are perfect for ripping open the roof skin of flat roofs in the event of sulphur fires. The ripping hooks are extremely widespread in fire brigades in the USA. The advantages thereof are gaining an increasing amount of acceptance in other country as well. They are just as light and indestructible as the ceiling hooks with NUPLA handle, and are available with the same dimensions and the same handle shapes.

Features:

- Feather light but yet extremely stable
- Sturdy, forged hook parts
- Choice of two handle shapes
- Good electrical insulation
- Extremely good price/performance ratio

Order no.	Handle shape	Length cm	Weight g
1 210473	Straight	183	3600
2 210474	D-handle	183	4300
210475	Straight	244	4000
210476	D-handle	244	4700
210477	Straight	305	4400
210478	D-handle	305	5000

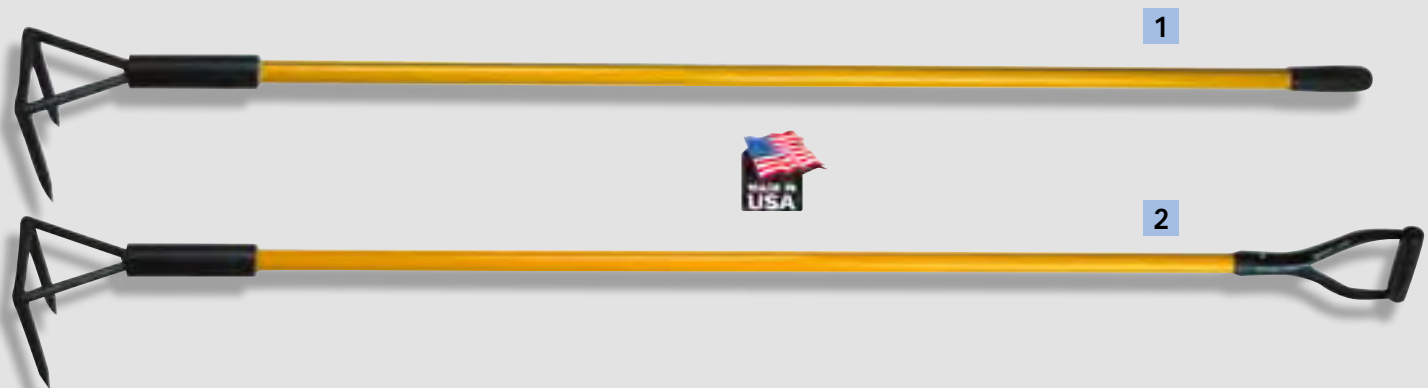

Nupla combination replacement system

This replacement system makes it possible to use different tools with a Nupla fibre glass handle. This makes the use of this extremely sturdy and robust tool handle even more attractive. Of course, just like the extension and the different tools, the replacement handle has all of the benefits of the special Nupla material.

A maximum of three parts can be combined.

The "roof kit" is a complete set, consisting of a ceiling hook part, rake hook part, D-grip handle and 120 cm extension.

Features:

- Quick tool changes
- Easier to use because of short handle
- Extremely versatile because of variable extension capability
- Two different tools can be used
- Sturdy D-grip for secure hold
- Extremely good price/performance ratio

Order no.	Name	Length cm	Weight g
1 210400	Ceiling hook part	90	1800
2 210402	Ripping hook part	90	2600
210404	Straight handle	90	1400
3 210406	D-grip handle	90	1700
4 210408	Extension	90	1200
210409	Extension	120	1500
210411	Roof kit 4-piece		7600



Axes with Nupla fibre glass handle

These axes, which are particularly widespread in the USA and other English-speaking countries, are popular because of their tremendous sturdiness. The NUPLA handle is almost unbreakable because of its special design and high proportion of fibre glass.

Whereas the "American design" fire brigade axe is used in a similar way to the German fire brigade axe, the Pulaski axe is mainly used for bush and forest fires. The blade of the axe is used to cut off hanging branches or

fell small trees, and the hoe can be used to create a fire break in any kind of ground.

Features:

- Handle is almost indestructible
- High quality, forged axe head
- Good electrical insulation
- Extremely good price/performance ratio

	Order no.	Head design	Length cm	Weight g
1	210480	American design	90	2800
2	210481	Pulaski	90	2900
3	201007	FB axe similar to DIN	90	2400



Bolt cutters with Nupla fibre glass grips

Extremely high quality and extremely sturdy screw cutters with NUPLA fibre glass grips. Extremely strong and insulating. Suitable for any type of use. Particularly cutting through hard material such as lock shackles is no problem for these screw cutters.

Features:

- Almost indestructible
- High quality forged blades for the hardest of materials
- Good electrical insulation
- Extremely good price/performance ratio

Order no.	for wire Ø	Length cm	Weight g
210482	8	450	1700
210483	11	600	2700
210484	13	760	4500
210485	16	910	6300



Fire rakes with Nupla fibre glass handle

Extremely sturdy special rake for making fire breaks in the forest floor. The sharp teeth of the rake dig effortlessly into dry and hard ground.

Features:

- Feather light but yet extremely stable
- Sturdy, ground teeth
- Extremely good price/performance ratio

Order no.	Length cm	Weight g
210486	152	2300

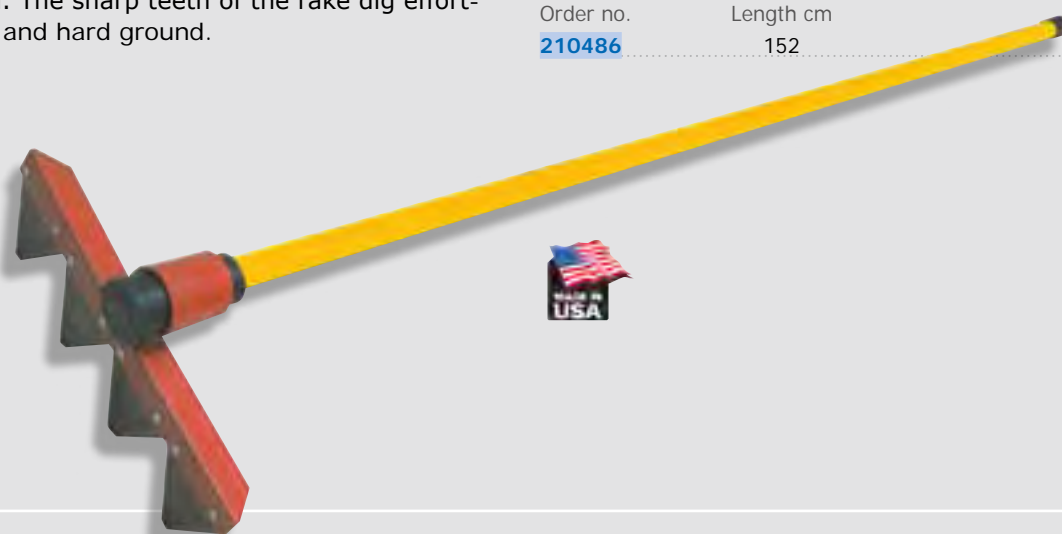

"McLeod-Tool" with Nupla fibre glass handle

Sturdy special tool for making fire breaks in the forest floor. The sharp hoe at one side cuts through roots, and the rake will dig effortlessly into dry and hard ground.

Features:

- Feather light but yet extremely stable
- Hoe at one side, rake at the other
- Extremely good price/performance ratio

Order no.	Length cm	Weight g
210487	122	6800

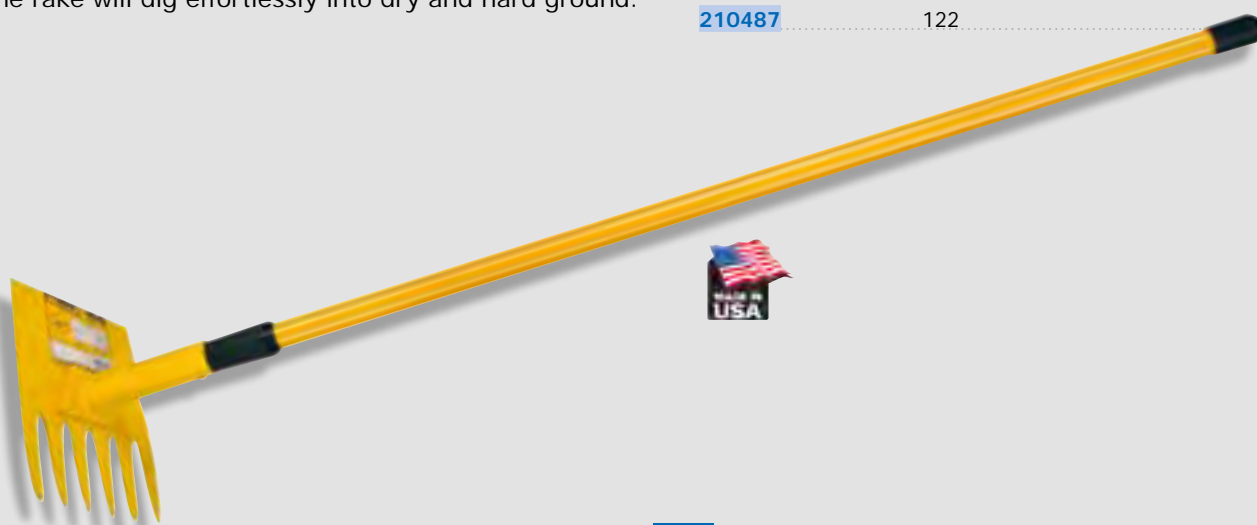

Sand shovel, Bavarian design

With ash handle, strong forged version, pointed design, varnished. Particularly suitable for fighting forest fires (making fire breaks), chopping off branches etc.

Order no.	Length mm	Weight g
1 210515	1600	2300

Pioneer shovel

Extremely short (960 mm) and handy ballast shovel, powder coated in black, blade size 300 x 240 mm, with CY handle.

Order no.	Item	Length mm	Weight g
2 210530	Shovel	960	2100
210532	Replacement CY handle		600

"Frankfurt" shovel DIN 20121

Powder coated in black, blade size 300 x 270 mm (size 5), with long beech handle.

Order no.	Item	Length mm	Weight g
3 210510	Shovel	1300	2000
210512	Spare handle		900

"Holstein" sand shovel DIN 20120

Powder coated in black, blade size 270 x 250 mm (size 2), with long beech handle.

Order no.	Item	Length mm	Weight g
4 210520	Shovel	1300	1800
210512	Spare handle		900

Square point shovel, lightweight material

Without protective steel edge, with 6 rivets in socket. Blade size 380 x 380 mm (size 9).

ATTENTION: Handle must be ordered separately!

Order no.	Item	Length mm	Weight g
5 210511	Shovel	1300	1100
210512	Spare handle		900



Square point shovel, non-sparking

Fine sandblasted finish, blade size 220 x 310 mm, with ash handle. Two handle shapes are available. For use in potentially explosive areas.

Order no.	Handle	Length mm	Weight g
285070	Long handle	1300	2000
285072	D-grip handle	980	2200

PP shovels

These corrosion-resistant shovels made from polypropylene (PP) are characterised by their light weight and their good resistivity. The surface is non-stick and completely corrosion resistant. The material is UV stabilised and unbreakable.

These shovels are ideal for dealing with aggressive materials such as road salt and oil binding materials. They are also suitable for use in potentially explosive areas.

Order no.	Size mm	Length mm	Grip	Weight g
210522	315 x 250	980	D-grip	1100
210525	350 x 260	1050	D-grip	1400



exclusive

Fire brigade spade DIN 20127

Powder coated in black, blade size 185 x 280 mm, with short ash handle. Two handle designs are available.

Order no.	Handle	Length mm	Weight g
210540	With CY-handle	1050	2200
210542	Replacement CY handle		700
210550	With T-handle	1050	2100
210552	Replacement T handle		600

Spade, non-sparking

Similar to DIN 20127, fine sandblasted finish, blade size 185 x 280 mm, with ash handle. Two handle designs are available.

For use in potentially explosive areas.

Order no.	Handle	Length mm	Weight g
280574	With T-handle	1160	2600
280576	With D-handle	1200	3000

Folding spade

Varnished in olive green, all metal, 240 mm in length when folded, blade size 210 x 155 mm.

Order no.	Model	Weight g
210560	Original german army version	1100
1 210565	Import version	1100



Railroad pick DIN 20109

Varnished in black, with oval eye and ash handle
950 mm long.

Order no.	Item	Size kg	Weight g
210610	Pickaxe	1,5	2300
210611	Spare handle	1,5	700
210630	Pickaxe	3,5	4300
210631	Spare handle	3,5	800



Railroad pick, non-sparking

Similar to DIN 20109, fine sandblasted finish, with oval eye and 950 mm ash handle.
For use in potentially explosive areas.

Order no.	Item	Size kg	Weight g
285068	Pickaxe	1,5	2200
210611	Spare handle	1,5	700
285069	Pickaxe	3,0	4800
210631	Spare handle	3,0	800



Dung hoe

Varnished in black, with 4 prongs, with long beech handle, with handle socket.

Order no.	Item	Length mm	Weight g
210661	Hoe	1350	1400
210662	Spare handle		900

Pitchfork

Varnished in black, with 4 prongs, with long, curved beech handle, with handle socket.

Order no.	Item	Length mm	Weight g
210651	Fork	1350	1300
210652	Spare handle		900



Ashlar fork

With nine prongs, 350 mm long, with long beech handle, with handle socket.

Order no.	Item	Length mm	Weight g
210670	Fork	1350	2800
210512	Spare handle		900

Piassava broom head

Beechwood road sweeping broom with Piassava bristles and metal threaded insert for attaching handle (screwed in).

ATTENTION: Handle must be ordered separately !

Order no.	Item	Weight g
210712	Broom 320 mm	600
210714	Broom 400 mm	800
210720	Wooden handle with metal thread	400



Elaston broom head

Beechwood road sweeping broom with red Elaston bristles and metal threaded insert for attaching handle (screwed in).

ATTENTION: Handle must be ordered separately !

Order no.	Item	Weight g
210716	Broom 400 mm	800
210720	Wooden handle with metal thread	400

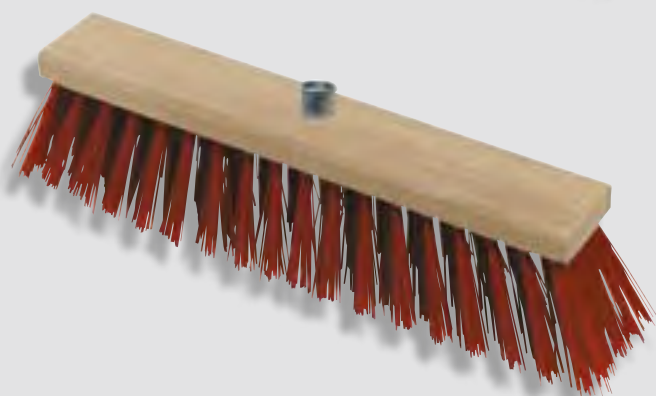

Rubber squeegee, metal

Made from metal with quick release mechanism, with double synthetic cellular rubber strip.

ATTENTION: Handle must be ordered separately !

Order no.	Item	Weight g
210730	Squeegee 560 mm	300
210732	Wooden handle 1400 mm	300

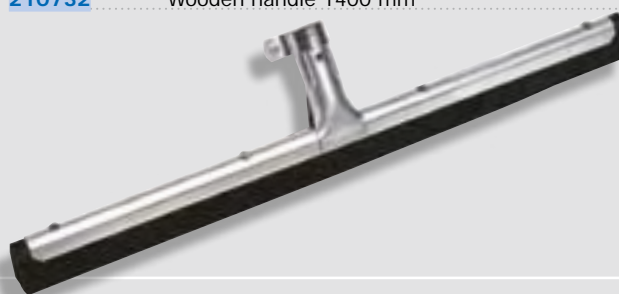

Rubber squeegee, wood

Made from wood, narrow version, with double synthetic cellular rubber strip.

For use in potentially explosive areas.

ATTENTION: Handle must be ordered separately !

Order no.	Item	Weight g
210735	Squeegee 600 mm	300
210732	Wooden handle 1400 mm	300



fix-o-mat-broom for indoors

Fix-o-mat brooms with micro structure bristles contain plastic structure particles made from gently cleaning plastic on the inside and the outside. The bristles get right down to the dirt and remove it more thoroughly than conventional brushes, from any floor and even textile structures, tile grout, carpets etc.

The broom head is made of plastic and comes with the well-tried fix-o-mat handle connection. This allows fix-o-mat system handles to be securely attached without problems.

Features:

- Plastic broom head
- fix-o-mat handle connection

Order no.	Bristle composition	Width mm	Weight g
1 210672	Flexon mixture/MicroStructure	280	290
2 210674	Natural hair/MicroStructure	280	280
210676	Natural hair/MicroStructure	400	435
3 210678	Natural hair/MicroStructure	600	670
4 210680	Artificial bristles/Arenga	280	355



made in Germany



made in Germany

fix-o-mat broom for outdoors

These micro-structure bristles provide the best results on any surface, even outdoors. Different widths and different bristle mixtures for different usage areas.

Features:

- Plastic broom head
- fix-o-mat handle connection
- Road sweeping broom (400 mm width) with scrubbing edge

Order no.	Bristle composition	Width mm	Weight g
1 210682	Artificial bristles/MicroStructure		
	with scrubbing edge	400	473
210684	Plastic bristles/MicroStructure	400	475
2 210686	Plastic bristles/MicroStructure	600	705
3 210688	Coconut fibre	400	390

fix-o-mat water squeegee

Fix-o-mat water squeegees meet the most demanding of requirements. The different versions cover all usage areas. The robust version and the high quality materials are also resistant to aggressive media and ensure that the tool has a long service life.

Plastic unit

Order no.	Version	Width mm	Weight g
1 210690	Foam rubber double strip with brush	430	210
210692	Foam rubber double strip without brush	440	180

Metal unit, plastic coated

Order no.	Version	Width mm	Weight g
2 210694	Foam rubber double strip	580	325

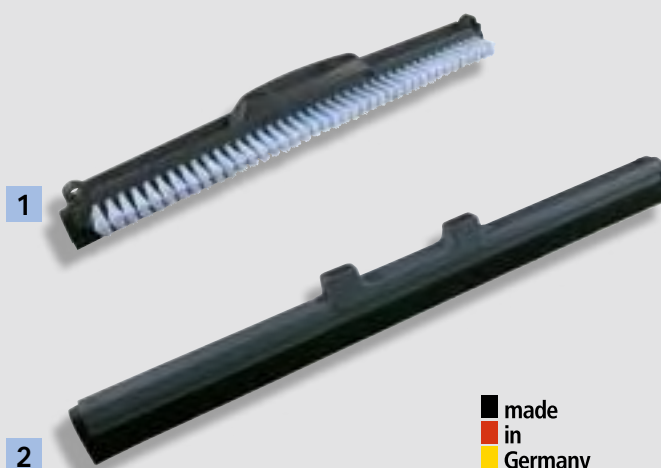

made
in
Germany

fix-o-mat system handles

Fix-o-mat system handles can be used in conjunction with all fix-o-mat attachments such as brooms, water squeegees etc. The handle is simply inserted into the body of the tool together with the special holder. Then simply clamp using the lever, and the connection is extremely secure.

The different handle variants provide the correct characteristics for any purpose of use.

Metal, rigid, extra sturdy

Order no.	Version	Length cm	Weight g
1 210700	Plastic coated	140	617
2 210702	Galvanised/chromatised	140	604

Metal, telescopic

Order no.	Version	Length cm	Weight g
3 210704	Anthracite/grey, varnished	130-223	688
4 210706	Plastic coated	92-157	384



made
in
Germany

Window wiper

Handy, small window wiper, suitable for drying vehicle windows prior to masking with film. Plastic handle with aluminium bar and special rubber strip.

Order no.	Width mm	Weight g
210966	290	110

